

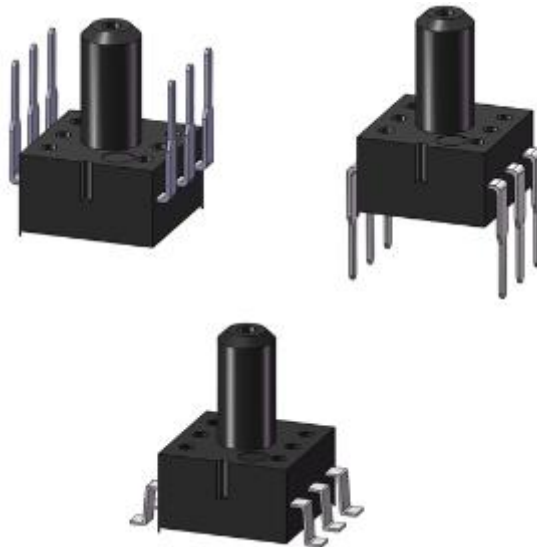

WF100S

PRODUCT INTRODUCTION:

WF100S series product is MEMS pressure sensor, the operation temperature range is $-40^{\circ}\text{C}\sim 125^{\circ}\text{C}$, the sensor has high accurate measurement capability within $-100\sim 200\text{kPa}$ and has very good linearity with output voltage. This series pressure sensor use SOP6 or DIP6 package which is suitable for lots application.



SPECIFICATIONS:

- Pressure range: $-100\sim 200\text{kPa}$
- High sensitivity
- Long term reliability
- Long term stability
- CC or CV supply
- Small package
- Low cost



APPLICATION

- Automobile electronic
- Consumer electronics
- Household electronic
- Industrial monitor and control
- Medicine care

1. PERFORMANCE SPECIFICATIONS

Table 1.1 specifications

Parameter	Min.	Typical	Max.	Unit	Remark
Supply Voltage	--	5	10	Vdc	
Supply Current		1		mAdc	
Pressure range	100(5/10/40/40/100/200/300/400)			kPa	
Bridge Resistance	4.5	5	5.5	kΩ	
Offset	-15	0	+15	mV	
Output @ full pressure	50	80	110	mV	
Linearity	--	0.2	0.5	%FS	
TCO	-0.08	-0.03	0.08	%FS/°C	CC type
	-0.08	-0.04	0.08	%FS/°C	CC type
TCS	-0.27	-0.22	-0.17	%FS/°C	CC type
	-0.05	±0.02	0.05	%FS/°C	CC type
TCR	1500	2000	2500	ppm/°C	
Stability	0.2			%FS/Y	
Hysteresis	--	0.05	0.1	%FS	
Overpressure	3X			--	
Operation temperature	-40	--	125	°C	
Storage temperature	-50	--	150	°C	
All product performance is tested under 5Vdc and 25±3°C					



2. APPLICATION SCHEMATIC

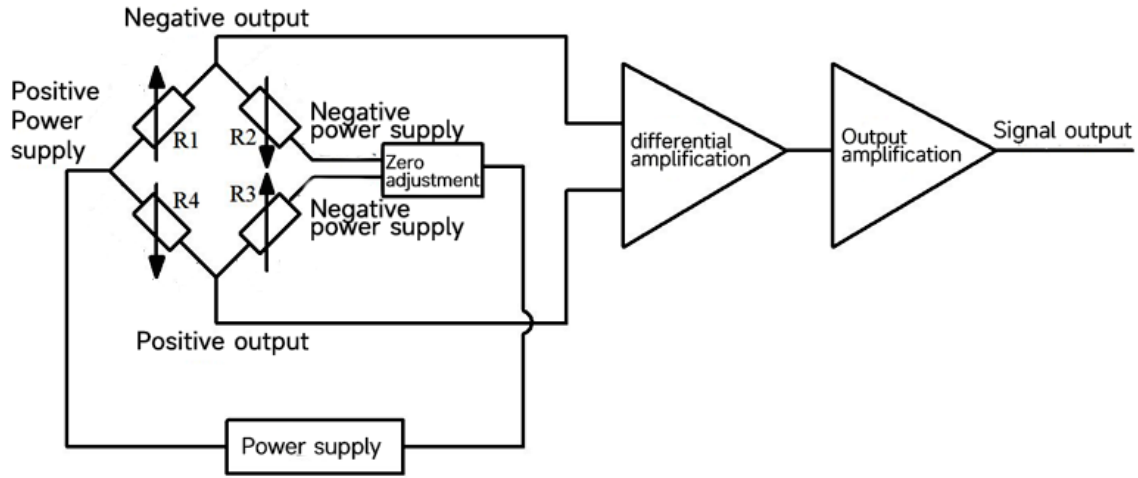

Picture 2.1 pressure sensor schematic

3. CONNECTIONS

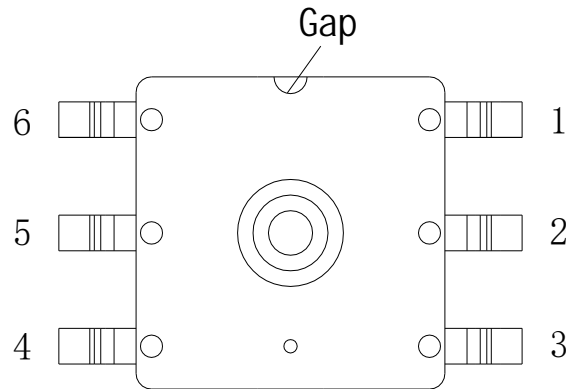

Picture3.1 Top view

Table3.1 O/I definition

Pin number	Definition
1	GND
2	Vout+
3	Vin+
4	NC
5	Vout-
6	GND

Remark: the connections definition is same for SOP and DIP package product



4. PRODUCT DIMENSIONS

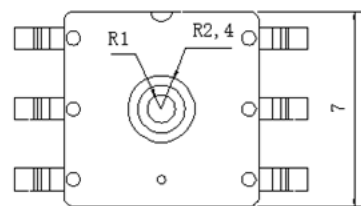
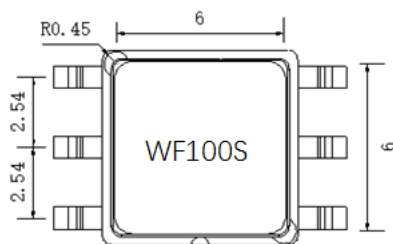
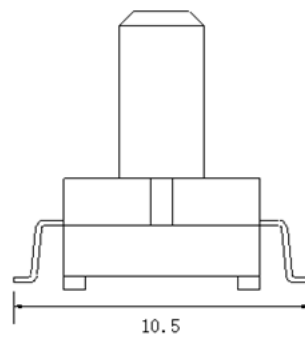
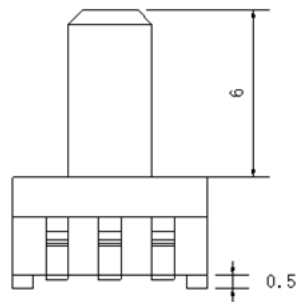
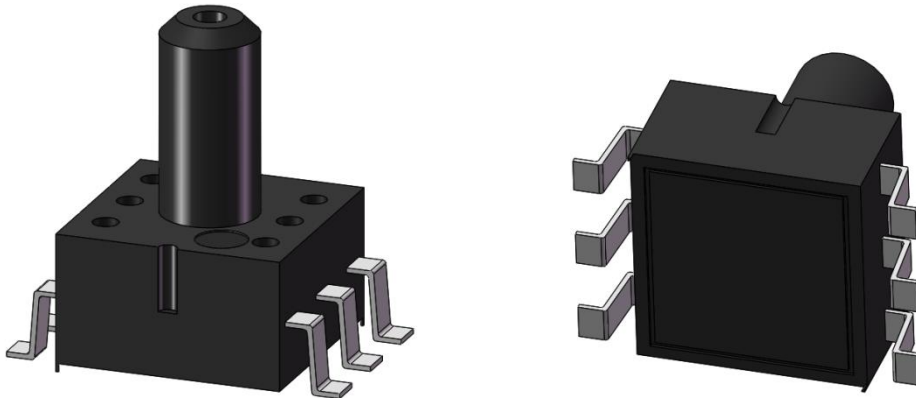

WF100S-SOP6



WF100S0100D-D Pressure Sensor

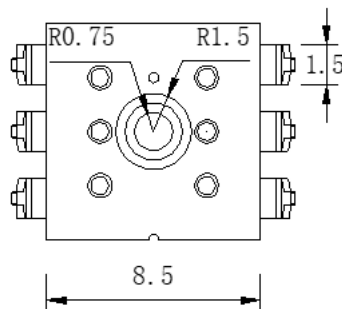
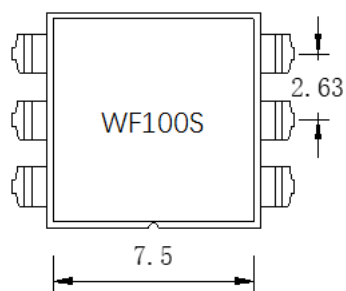
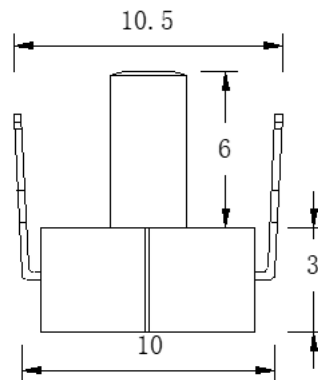
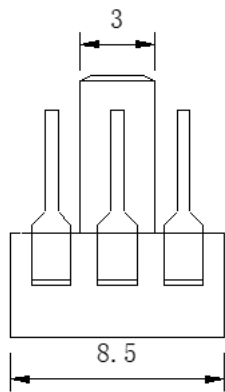
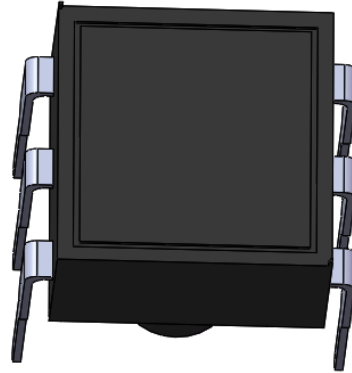
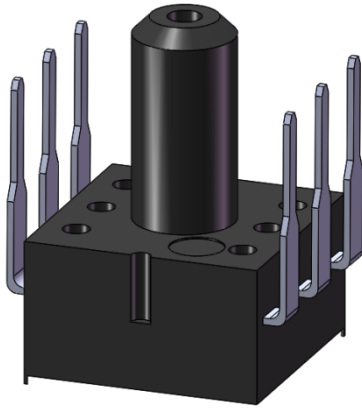

WF100S-DIP6 Bottom Tube



WF100S0100D-D Pressure Sensor

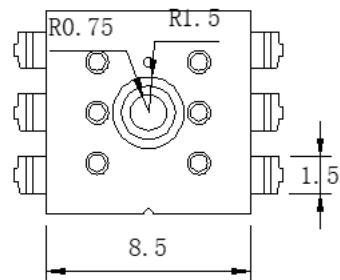
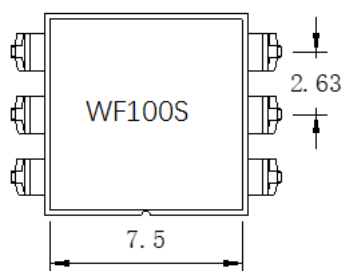
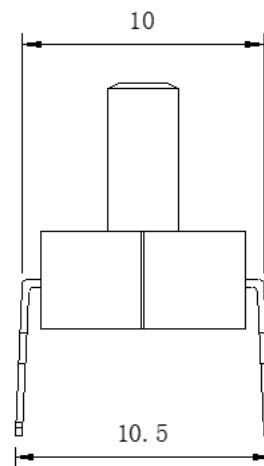
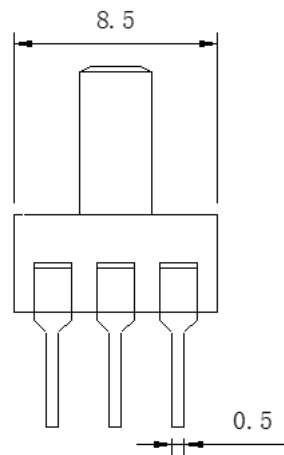
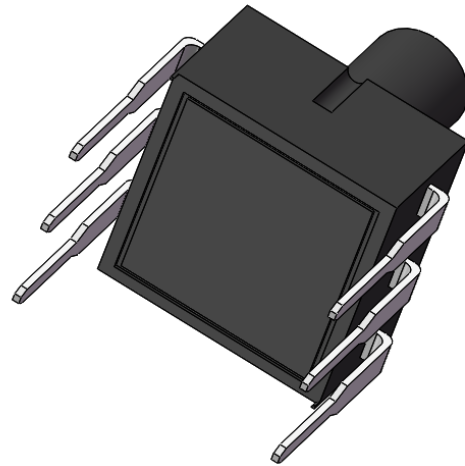
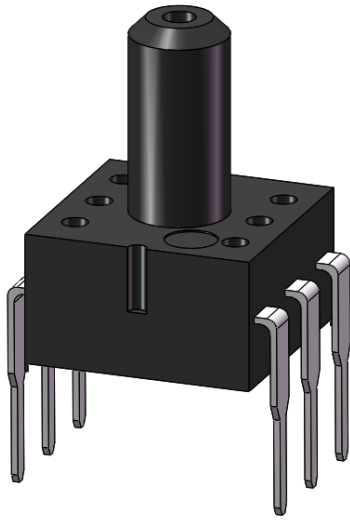

WF100S DIP6 Top Tube



5. ORDER INFORMATION

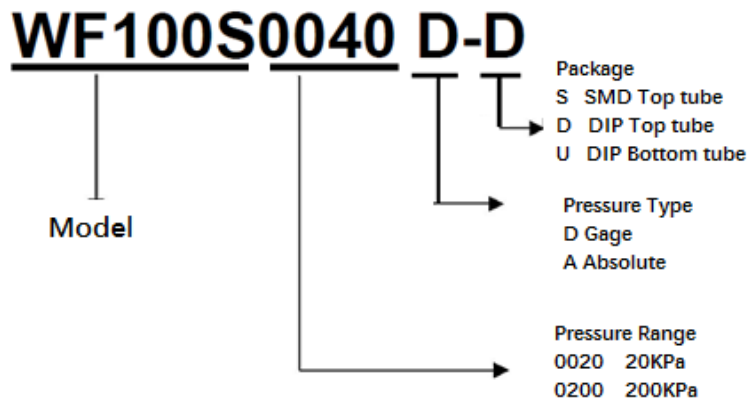

Note:

D	DIP Top tube
U	DIP Bottom tube
S	SMD Top tube
8	SO8 Hole
N	SMALL DIP Top tube
SU	SMD bottom tube
Q	QFN
5Q	DFN (5*5)